



SPLIT-TYPE AIR CONDITIONERS

Model

**MXZ-3A30NA**

[FLARE CONNECTION TYPE]



**Mr. SLIM**

## INSTALLATION MANUAL

### ATTENTION

This manual mentions how to install only the outdoor unit, MXZ-3A30NA. As for the way of installation for indoor unit (MSZ-A09NA, MSZ-A12NA, MSZ-A15NA, MSZ-A17NA and MSZ-A24NA), please refer to the installation manual being attached each indoor unit.

The installation manual details the suggested installation method.

Any structural alterations necessary for installation must comply with local building code requirements.

**FOR INSTALLER**

# CONTENTS

English

Español

1. THE FOLLOWING SHOULD ALWAYS BE OBSERVED FOR SAFETY .....	2
2. INSTALLATION DIAGRAM & ACCESSORIES .....	2
3. SELECTING THE INSTALLATION LOCATION .....	3
4. OUTDOOR UNIT INSTALLATION .....	4
5. INDOOR/OUTDOOR UNITS CONNECTION FINISHING AND TEST RUN .....	6

# 1. THE FOLLOWING SHOULD ALWAYS BE OBSERVED FOR SAFETY

- Please report to your supply authority or obtain their consent before connecting this equipment to the power supply system.
- Be sure to read “THE FOLLOWING SHOULD ALWAYS BE OBSERVED FOR SAFETY” before installing the air conditioner.
- Be sure to observe the cautions specified here as they include important items related to safety.
- The indications and meanings are as follows.

 **WARNING:** Could lead to death, serious injury, etc.

 **CAUTION:** Could lead to serious injury in particular environments when operated incorrectly.

- After reading this manual, be sure to keep it together with the INSTRUCTION MANUAL in a handy place on the customer’s site.

## WARNING

- **Do not install the unit by yourself (customer).**  
Incomplete installation could cause injury due to fire, electric shock, the unit falling or leakage of water. Consult the dealer from whom you purchased the unit or special installer.
- **Install the unit securely in a place which can bear the weight of the unit.**  
When installed in an insufficient strong place, the unit could fall causing injury.
- **Use the specified wires to connect the indoor and outdoor units securely and attach the wires firmly to the terminal block connecting sections so the stress of the wires is not applied to the sections.**  
Incomplete connecting and fixing could cause fire.
- **Do not use intermediate connection of the power cord or the extension cord and do not connect many devices to one AC outlet.**  
It could cause a fire or an electric shock due to defective contact, defective insulation, exceeding the permissible current, etc.
- **Check that the refrigerant gas does not leak after installation has completed.**  
If refrigerant gas leaks indoors, and comes into contact with the fire of a fan heater, space heater, stove, etc., harmful substances will be generated.
- **Perform the installation securely referring to the installation manual.**  
Incomplete installation could cause a personal injury due to fire, electric shock, the unit falling or leakage of water.
- **Perform electrical work according to the installation manual and be sure to use an exclusive circuit.**  
If the capacity of the power circuit is insufficient or there is insufficient electrical work, it could result in a fire or an electric shock.
- **Attach the electrical cover to the indoor unit and the service panel to the outdoor unit securely.**  
If the electrical cover in the indoor unit and/or the service panel in the outdoor unit are not attached securely, it could result in a fire or an electric shock due to dust water, etc.
- **Be sure to use the part provided or specified parts for the installation work.**  
The use of defective parts could cause an injury due to a fire, an electric shock, the unit falling, leakage of water, etc.
- **Be sure to cut off the main power in case of setting up the indoor electronic control P.C. board or wiring works.**  
It could cause an electric shock.
- **The appliance shall be installed in accordance with national wiring regulations.**
- **When installing or relocating the unit, make sure that no substance other than the specified refrigerant (R410A) enters the refrigerant circuit.**  
Any presence of foreign substance such as air can cause abnormal pressure rise or an explosion.

## CAUTION

- **Perform grounding.**  
Do not connect the ground wire to a gas pipe, water pipe, lightning rod or telephone ground wire. Defective grounding could cause an electric shock.
- **Do not install the unit in a place where an inflammable gas leaks.**  
If gas leak and accumulate in the area surrounding the unit, it could cause an explosion.
- **Fasten a flare nut with a torque wrench as specified in this manual.**  
When fastened too tight, a flare nut may broken after a long period and cause a leakage of refrigerant.
- **Install a ground leakage breaker depending on the installation place (Where it is humid).**  
If a ground leakage breaker is not installed, it could cause an electric shock.
- **Perform the drainage/piping work securely according to the installation manual.**  
If there is a defect in the drainage/piping work, water could drop from the unit and household goods could be wet and damaged.

# 2. INSTALLATION DIAGRAM & ACCESSORIES

## Before installation

This installation manual is only for the outdoor unit installation. In installing the indoor units, refer to the installation manual attached to each indoor unit. Any structural alternations necessary for the installation must comply with the local building code requirements.

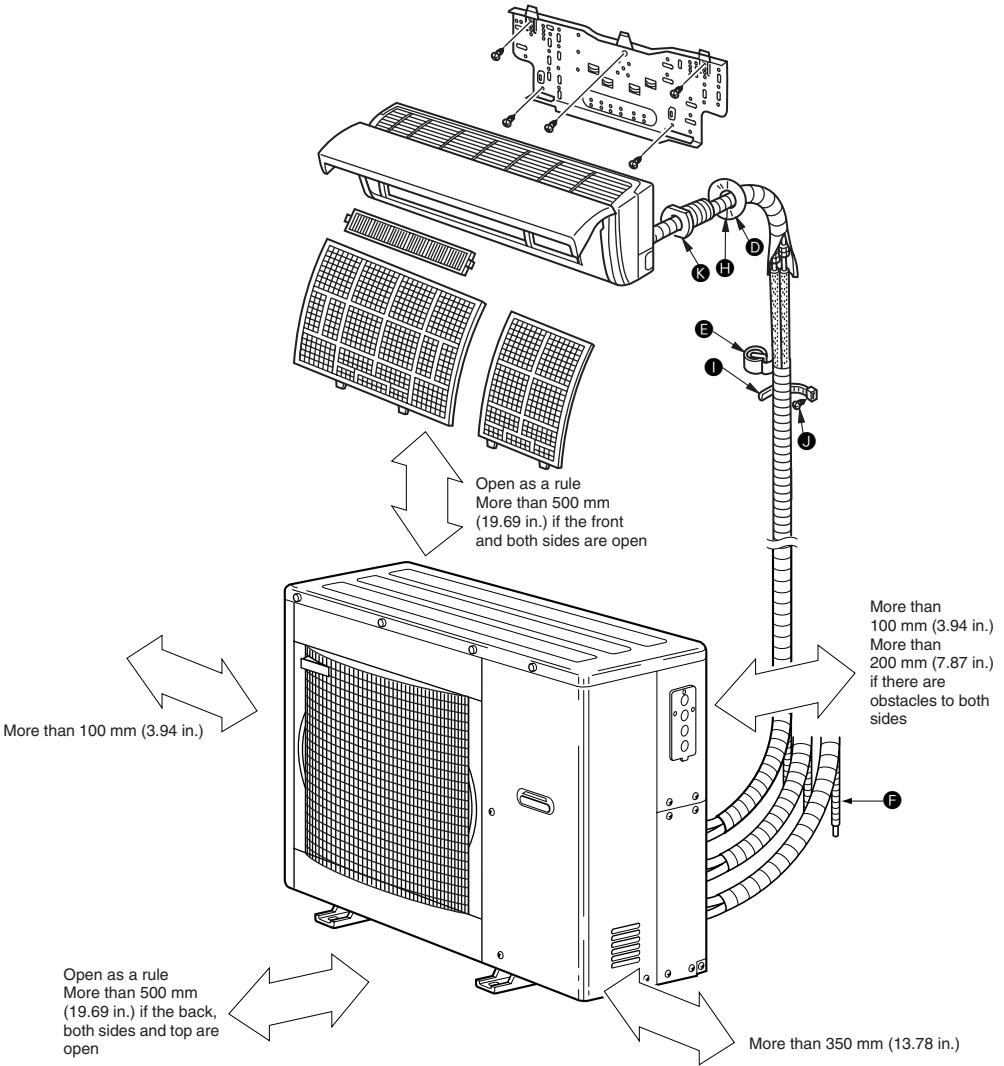

**Note:**

The dimensions given along the arrows above are required to guarantee the air conditioner's performance. Install the unit in as wide a place as possible for later service or repairs.

## Parts to be locally procured

Ⓐ	Power supply cord	1
Ⓑ	Indoor/outdoor unit connecting wire	1
Ⓒ	Extension pipe According to "Selecting pipe size"	1
Ⓓ	Wall hole cover	1
Ⓔ	Piping tape	1
Ⓕ	Extension drain hose (or soft vinyl chloride hose of 15 mm (19/32 in.) in internal dia.)	1
Ⓖ	Refrigeration oil	Little amount
Ⓗ	Putty	1
Ⓘ	Pipe fixing band (The number depends on the pipe length.)	2 to 7
Ⓝ	Fixing screw for Ⓘ (The number depends on the pipe length.)	2 to 7
Ⓚ	Wall hole sleeve	1
Ⓛ	Soft vinyl chloride hose of 25 mm (31/32 in.) in internal dia. or hard vinyl chloride pipe VP25	1

- The "Q'ty" for Ⓑ to Ⓚ in the above table is the quantity to be used per indoor unit.

### **WARNING:**

**Be sure to use specified accessories and supplied parts for installation work. If there is some deficiency in parts, it may cause a risk of fire, electric shock, injury because of a unit fall or water leakage.**

## Constraints On Indoor Unit Installation

You should note that indoor unit that can be connected to this outdoor unit have the following constraints on them.

- Indoor units with model numbers 09, 12, 15, 17 and 24 can be connected. Refer to the table below for possible two-room and three-room indoor unit combinations.

Combination (Models)					
09+09	09+12	09+15	09+17	09+24	12+12
12+15	12+17	15+15	15+17	17+17	09+09+09
09+09+12	09+09+15	09+09+17			

### 3. SELECTING THE INSTALLATION LOCATION

- Where it is not exposed to strong wind.
- Where airflow is good and dustless.
- Where it is not exposed to rain and direct sunshine.
- Where neighbours are not annoyed by operation sound or hot air.
- Where solid wall or support is available to prevent the increase of operation sound or vibration.
- Where there is no risk of combustible gas leakage.
- When installing the unit at a high level, be sure to fix the unit legs.
- Where it is at least 3 m (9.84 ft.) away from the antenna of TV set or radio. (Otherwise images would be disturbed or noise would be generated.)
- Install the unit at level.

**Note:**

It is advisable to make a piping loop near outdoor unit so as to reduce vibration transmitted from there.

**⚠ WARNING:**

Be sure to install the unit in a place that well sustains its weight.  
Installing in a place with less strength may result in a unit falling, causing a risk of injury.

**⚠ CAUTION:**

Avoid the following places for installation where air conditioner trouble may occur.

- Where there is too much machine oil.
- Salty environment such as seaside areas.
- Hot-spring areas.
- Where sulfide gas exists.
- Other special atmospheric areas.

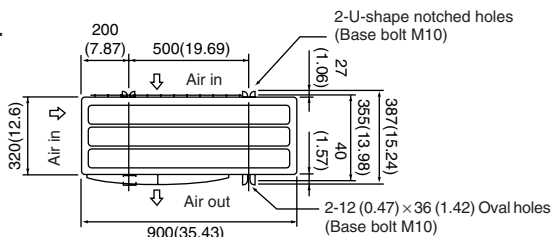

[Unit: mm (inch)]

**Note:**

When operating the air conditioner in low outside temperature, be sure to follow the instructions described below.

- Never install the outdoor unit in a place where its air inlet/outlet side may be exposed directly to wind.
- To prevent exposure to wind, install the outdoor unit with its air inlet side facing the wall.
- To prevent exposure to wind, it is recommended to install a baffle board on the air outlet side of the outdoor unit.

## FREE SPACE REQUIRED AROUND OUTDOOR UNIT [Unit: mm (inch)]

### 1. Top side obstacles

When there is an obstacle behind the rear side only, it does not matter if there is an obstacle over the top side as shown in the figure below.

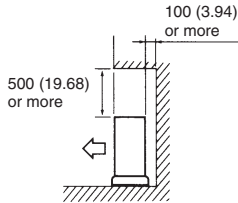

### 2. Front (blowing) side open

As long as space like the one shown in the figure can be maintained, it does not matter if there are obstacles in there direction (but top side is open).

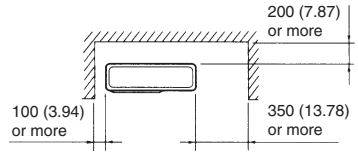

### 3. Obstacles on front (blowing) side only

In this case, the rear, both sides and top should be open.

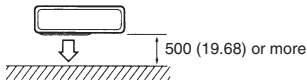

### 4. Obstacles on front and rear side only

An optional outdoor blowing guide (MAC-855SG) can be attached to the unit but both sides and top are open.

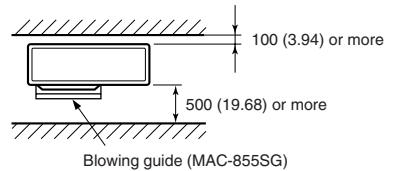

### 5. Service space

Keep the service space as shown in the figure below for maintenance.

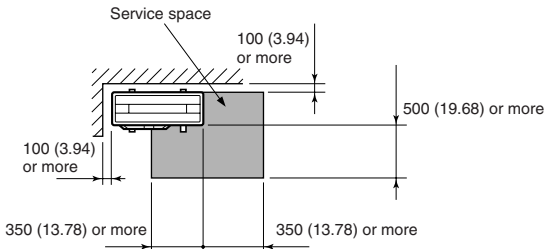

## 4. OUTDOOR UNIT INSTALLATION

### 4-1 INSTALLING THE UNIT

- Be sure to fix the unit's legs with bolts when installing it.
- Be sure to install the unit firmly to ensure that it does not fall from an earthquake or from a gust of wind.
- Refer to the figure at right when using a concrete foundation.

**Note:**

The length of anchor bolts should be within 25 mm (1 in.) from each anchor leg.

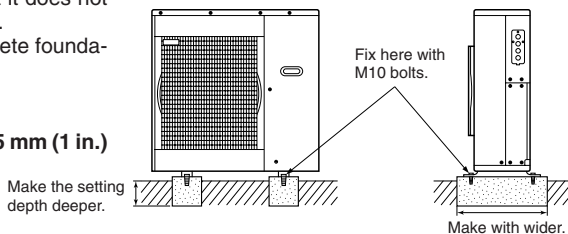

**CAUTION:**

Be sure to carry out drain pipe work following the installation manual.

If there is some deficiency in drain and pipe work, it may cause risk of dripping from the unit, wetting or damaging your property.

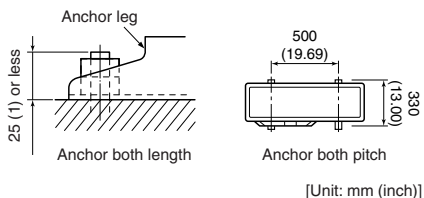

### 4-2 MOUNTING ARRANGEMENT OF DRAIN SOCKET

- ① Please choose one hole to discharge drain and install the drain socket to the hole.
- ② Please close the rest of the holes with the drain caps.

**CAUTION:**

Do not use drain socket and drain cap in the cold region. Drain may freeze and it makes the fan stop.

- ③ Please connect a vinyl hose of 25 mm (1 in.) in the inside diameter on the market with the drain socket and lead drain.

### 4-3 HOW TO REMOVE THE SERVICE PANEL AND THE CONNECT COVER

- Remove the four service panel securing screws, and pull the panel down in an arrow direction to remove the service panel.
- Remove the four connect cover securing screws to remove the connect cover.

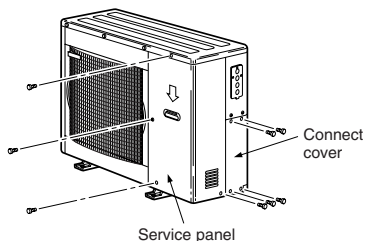



<Front View>

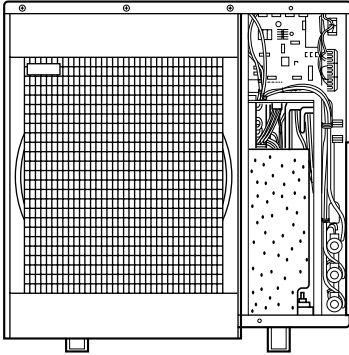

<Right Side View>

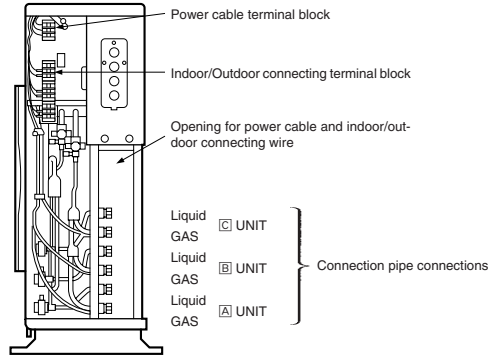

## 4-4 INDOOR/OUTDOOR WIRE CONNECTION AND OUTDOOR POWER SUPPLY CORD CONNECTION

- Be sure to use special circuits for room air conditioner.
- Wiring work should be based on applicable technical standards.
- Wiring connections should be made following the diagram.
- Screws should be tightened so they won't loosen.

ELECTRICAL SPECIFICATIONS					
INDOOR UNIT	MSZ-A09NA	MSZ-A12NA	MSZ-A15NA	MSZ-A17NA	MSZ-A24NA
Power supply (V, PHASE, Hz)	208/230, 1, 60				
Min. Circuit Ampacity (A)	1.0	1.0	1.0	1.0	1.0
Fan motor (F.L.A)	0.76	0.76	0.76	0.76	0.76
OUTDOOR UNIT			MXZ-3A30NA		
Power supply (V, PHASE, Hz)	208/230, 1, 60				
Max. Fuse size (time delay) (A)	20				
Min. Circuit Ampacity (A)	15				
Fan motor (F.L.A)	0.93				
Compressor	(R.L.A)	11			
	(L.R.A)	15			
Control voltage	Indoor unit-Remote controller : (Wireless) Indoor unit-Outdoor unit : DC12-24V				

- A disconnect switch may be required. Check the local code.

**Remark:**

- \* A disconnect switch may be required. Check the local code.
- \*\* Use a ring tongue terminal in order to connect a ground wire to terminal.

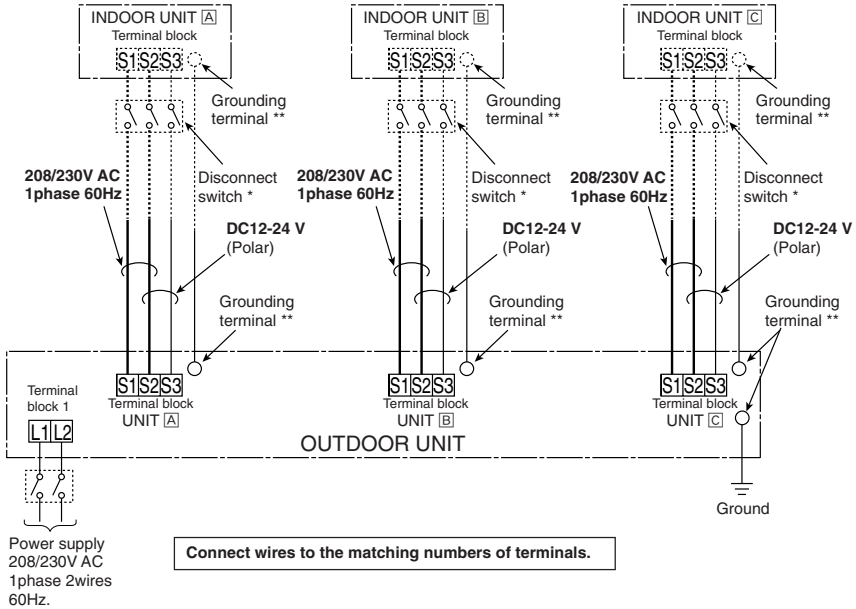

**CONNECTING WIRES**

- Wire to be AWG22 double insulated, 300 V insulation. Equal to Belden 9407 (for 12-24 V DC).
- Use copper conductors only.

**Note:**

- \*1 Wire to be AWG22 double insulated, 300 V insulation. Equal to Belden 9407.
- \*2 Power supply cable and grounding wire must use copper wire AWG14.
- \*3 Connect grounding wire with grounding terminal by using a ring tongue solderless terminal.

**⚠ WARNING:**

Use the indoor/outdoor unit connecting wire that meets the Standards to connect the indoor and outdoor units and fix the wire to the terminal block securely so that no external force is conveyed to the connecting section of the terminal block. An incomplete connection or fixing of the wire could result in a fire.

- 1 Remove the service panel.
- 2 Fix the conduit connector to conduit cover with lock nut then secure it against unit with screws.
- 3 Fix the conduit cover to the outdoor unit then secure it with screws.
- 4 Connect power supply and indoor/outdoor connecting wire to the terminal block.  
(Leave some slack in wires to allow easier servicing.)

**⚠ CAUTION:**

Use care so as connecting wires do not contact pipes.

**⚠ WARNING:**

Be sure to attach the terminal block covers (panel) of both indoor and outdoor units. If there is some deficiency in terminal block cover (panel) attachment, it may cause a risk of fire or electric shock due to dust or water.

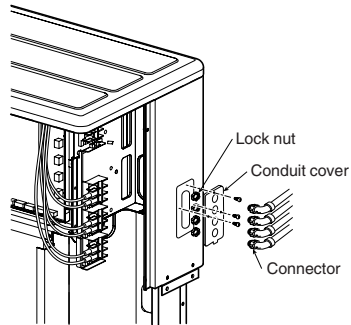

# 5. INDOOR/OUTDOOR UNITS CONNECTION FINISHING AND TEST RUN

## 5-1 TOOLS DEDICATED FOR THE AIR CONDITIONER WITH R410A REFRIGERANT

The following tools are required for R410A refrigerant. Some R22 tools can be substituted for R410A tools.

R410A tools	Can R22 tools be used?	Description
Gauge manifold	No	R410A has high pressures beyond the measurement range of existing gauges.
Charge hose	No	Hose material and cap size have been changed to improve the pressure resistance.
Gas leak detector	No	Dedicated for HFC refrigerant.
Torque wrench	Yes	1/4 and 3/8
	No	1/2 and 5/8
Flare tool	Yes	Clamp bar hole has been enlarged to reinforce the spring strength in the tool.
Flare gauge	New	Provided for flaring work (to be used with R22 flare tool).
Vacuum pump adaptor	New	Provided to prevent the back flow of oil. This adapter enables you to use existing vacuum pumps.
Electronic scale for refrigerant charging	New	It is difficult to measure R410A with a charging cylinder because the refrigerant bubbles due to high pressure and high-speed vaporization.

No: Not substitutable for R410A Yes: Substitutable for R410A

## 5-2 FLARED CONNECTIONS

### PIPE LENGTH AND HEIGHT DIFFERENCE

Limits	
Pipe length per indoor unit	25 m (82 ft.) max.
Total pipe length for multi-system	70 m (230 ft.) max.
Height difference	10 m (33 ft.) max.
No. of bends per indoor unit	25 max.
Total No. of bends for multi-system	70 max.

Refrigerant adjustment ..... If pipe length exceeds 40 m (131 ft.), additional refrigerant (R410A) charge is required.

(The outdoor unit is charged with refrigerant for total pipe length up to 40 m (131 ft.).)

Pipe length	Up to 40 m (131 ft.)	No additional charge is required.
	Exceeding 40 m (131 ft.)	Additional charge is required. (Refer to the table below.)
Refrigerant to be added	1.06 oz each 5 ft.	

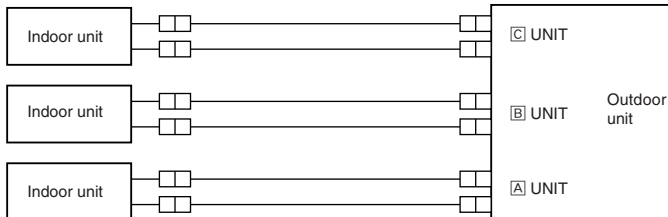

- For pipe size, see the table below.

## SELECTING PIPE SIZE

The diameter of connection pipes differs according to the type and capacity of indoor units. Match the diameters of connection pipes for indoor and outdoor units according to the following table.

Model name	Pipe size for indoor unit		Allowable connection pipe size mm (in.)
	mm (in.)		
09/12	Liquid pipe	ø6.35 (1/4)	ø6.35 (1/4)
	Gas pipe	ø9.52 (3/8)	
15/17	Liquid pipe	ø6.35 (1/4)	ø6.35 (1/4)
	Gas pipe	ø12.7 (1/2)	
24	Liquid pipe	ø6.35 (1/4)	ø6.35 (1/4)
	Gas pipe	ø15.88 (5/8)	

Valve size for outdoor unit mm (in.)		
A UNIT	Liquid pipe	ø6.35 (1/4)
	Gas pipe	ø12.7 (1/2)
B UNIT	Liquid pipe	ø6.35 (1/4)
	Gas pipe	ø9.52 (3/8)
C UNIT	Liquid pipe	ø6.35 (1/4)
	Gas pipe	ø9.52 (3/8)

- If the diameter of connection pipes does not match the diameter of pipe end connections, use optional different-diameter joints.
- When connecting the model 15 and 17 to either outdoor unit B or C, use optional different-diameter joints (MAC-454JP) because the valve size of gas pipes for the outdoor unit is ø9.52 mm (3/8 in.).
- When connecting the model 09 and 12 to either outdoor unit A, use optional different-diameter joints (MAC-455JP) because the valve size of gas pipes for the outdoor unit is ø12.7 mm (1/2 in.).
- When connecting the model 24 to outdoor unit A, use optional different-diameter joints (MAC-456JP) because the diameter of pipes for the outdoor unit is ø12.7 mm (1/2 in.).

## PIPE PREPARATION

① If you use commercially available copper pipes, use the following table for pipe specifications.

	Outside diameter	Minimum Wall thickness	Insulation thickness	Insulation material
	mm (in.)	mm (in.)	mm (in.)	
Liquid pipe	ø6.35 (1/4)	0.67 (0.0265)	8 (5/16)	Heat resisting from plastic 0.045 Specific gravity
Gas pipe	ø9.52 (3/8)	0.72 (0.0285)	8 (5/16)	
Gas pipe	ø12.7 (1/2)	0.72 (0.0285)	8 (5/16)	
Gas pipe	ø15.88 (5/8)	0.80 (0.0315)	8 (5/16)	

② Ensure that the 2 refrigerant pipes are insulated to prevent condensation.

③ Refrigerant pipe bending radius must be 100 mm (4 in.) or more.

### ⚠ CAUTION:

**Be sure to use the insulation of specified thickness. Excessive thickness may cause incorrect installation of the indoor unit and lack of thickness may cause dew drippage.**

## 5-3 FLARING WORK

- Main cause of gas leakage is defect in flaring work.  
Perform flaring work correctly in the following procedure.

### 1. Pipe cutting

- Cut the copper tube correctly with pipe cutter.

### 2. Burrs removal

- Completely remove all burrs from the cut cross section of the pipe/tube.
- Put the end of the copper tube downward to prevent burrs from dropping in the pipe/tube.

### 3. Putting nut on

- Remove flare nuts attached to indoor and outdoor units, then put them on pipe/tube having completed burr removal.  
(not possible to put them on after flaring work)

### 4. Flaring work

- Perform flaring work using flaring tool as shown in the right.

Pipe diameter mm (in.)	A in.
ø6.35 (1/4)	0.06 to 0.08
ø9.52 (3/8)	0.06 to 0.08
ø12.7 (1/2)	0.08 to 1.0
ø15.88 (5/8)	0.08 to 1.0

Firmly hold copper tube in a die in the dimension shown in the table above.

### 5. Check

- Compare the flared work with the figure below.
- If flare is noted to be defective, cut off the flared section and perform flaring work again.

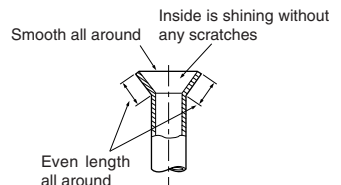
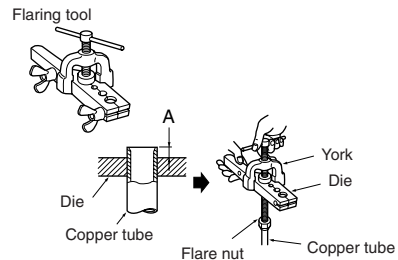
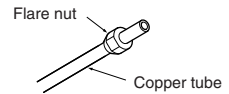
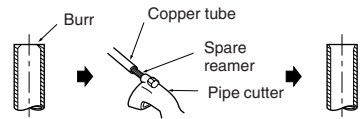
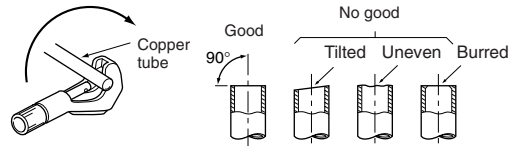

## 5-4 PIPE CONNECTION

**Note:**  
Fasten a flare nut with a torque wrench as specified in the table below.

When fastened too tight, a flare nut may be broken after a long period and cause a leakage of refrigerant.

### 1. Indoor unit connection

- Connect both liquid pipe and gas pipe to indoor unit.
  - Apply a thin coat of refrigeration oil to the seat surface of pipe.
  - For connection, first align the center, then hand tighten the first 3 to 4 turns of flare nut.
  - Uses tightening torque table at the right as a guideline for indoor unit side union joint section, and tighten using two wrenches excessive tightening damage the flared section.

Pipe diameter mm (in.)	Tightening torque	
	N·m	ft·lb
ø6.35 (1/4)	13.7 to 17.7	10 to 13
ø9.52 (3/8)	34.3 to 41.2	25 to 30
ø12.7 (1/2)	49.0 to 56.4	36 to 42
ø15.88 (5/8)	73.5 to 78.4	54 to 58

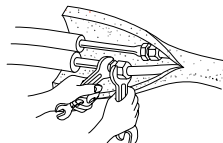

### 2. Outdoor unit connection

- Connect pipes to stop valve (2-way and 3-way valve) pipe joints of the outdoor unit in the same manner application indoor unit.
  - For tightening, use a torque wrench or spanner and use the same tightening torque applied for indoor unit.

## INSULATION AND TAPING

- ① Cover piping joints with pipe cover.
  - ② For outdoor unit side, surely insulate every piping including valves.
  - ③ Using piping tape **E**, apply taping starting from the entry of outdoor unit.
- Fix the end of piping tape **E** with adhesive tape.
  - When piping has to be arranged through above ceiling, closet or area where the temperature and humidity are high, wind additional commercially sold insulation for prevention of condensation.

## 5-5 PURGING PROCEDURES • LEAK TEST

- Perform the manifold valve work securely according to the installation manual of the manifold valve.

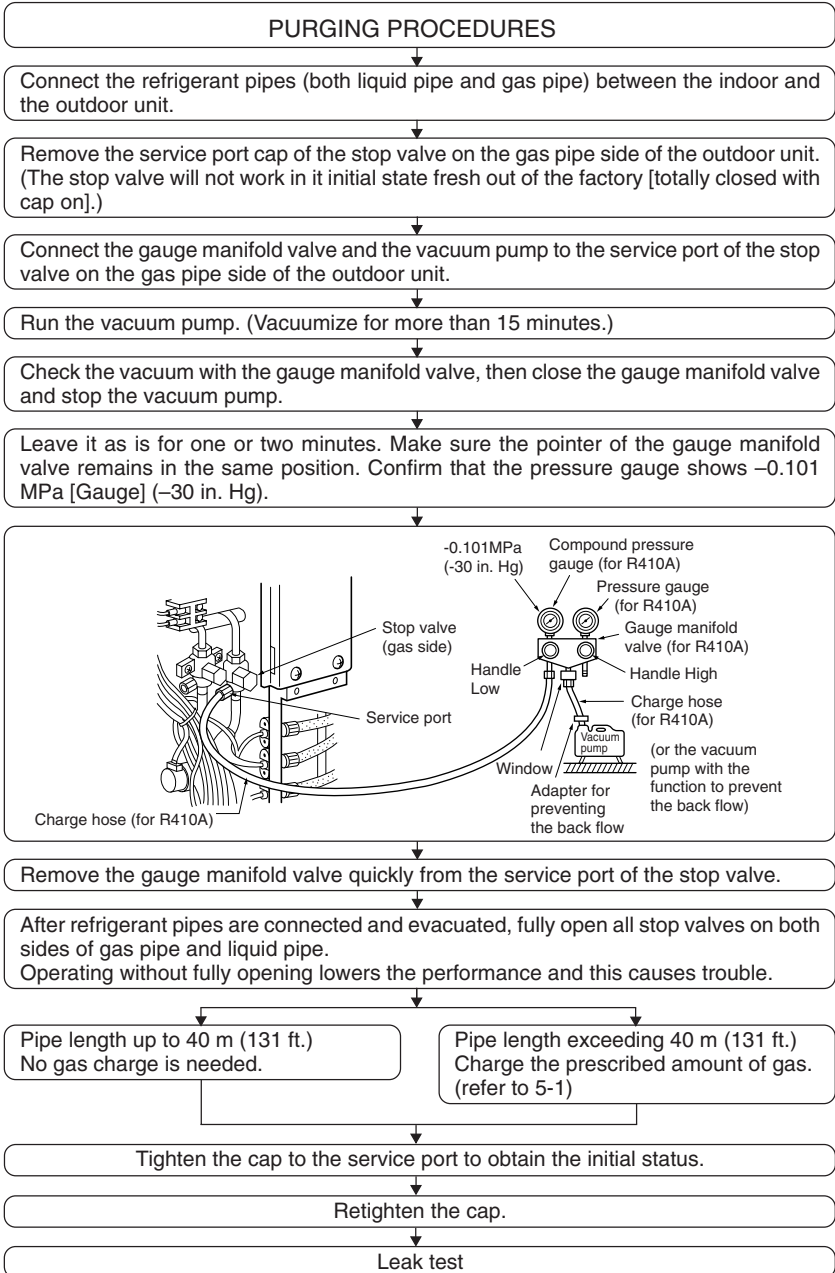

**⚠ WARNING:**

**When installing or moving the unit, do not mix anything other than specified refrigerant (R410A) into the refrigerating cycle.**

**If air is mixed, it may cause the refrigerating cycle to get abnormally high temperature, causing a risk of burst.**

	Tightening torque	
	N·m	ft.·lb
Cap for service port	13.7 to 17.7	10 to 13
Cap for stop valve	19.6 to 29.4	15 to 22

## 5-6 GROUNDING WORK

Put the ground circuit to the ground in accordance with “Technical Standards for Electrical Installation”.

**⚠ CAUTION:**

**Do not connect the ground cable to any gas pipe, water pipe, lightning rod or telephone ground cable. If there is some deficiency in grounding work, it may cause a risk of electric shock.**

The product incorporates a frequency inverter and so requires grounding in order to observe electric charge and noise caused by static electricity.

## 5-7 CHECKING AFTER INSTALLATION

After finishing the installation, check the following items again by making .

- Have special circuits been provided?
- Is power supply voltage as specified?
- Has indoor/outdoor connecting wire been inserted into terminal block?
- Has indoor/outdoor connecting wire been secured firmly?
- Has intermediary connection between power cable and indoor/outdoor connecting wire been carried out?
- Is combination of connection pipes and indoor/outdoor connecting wire correct (Room A, Room B, Room C, Room D)?
- Is ground cable connection correct?
- Has leak test been carried out?
- Has air purge been carried out?
- Is stop valve fully open?
- Has drain discharge been checked?
- Is insulation over connection pipe joints correct?
- Is strength of installation location well enough?
- Have all of **⚠ WARNING** and **⚠ CAUTION** items in “1. THE FOLLOWING SHOULD ALWAYS BE OBSERVED FOR SAFETY” been checked?



## 5-8 GAS CHARGE

Perform gas charge to unit.

- ① Connect gas cylinder to the service port of stop valve.
- ② Perform air purge of the pipe (or hose) coming from refrigerant gas cylinder.
- ③ Replenish specified amount of the refrigerant, while operating the air conditioner for cooling.

### Note:

In case of adding refrigerant, comply with the quantity specified for the refrigerating cycle.

### ⚠ CAUTION:

When charging the refrigerant system with additional refrigerant, be sure to use liquid refrigerant. Adding gas refrigerant may change the composition of the refrigerant in the system and affect normal operation of the air conditioner. Also, charge the system slowly, otherwise the compressor will be locked.

To maintain the high pressure of the gas cylinder, warm the gas cylinder with warm water (under 140°F) during cold season. But never use naked fire or steam.

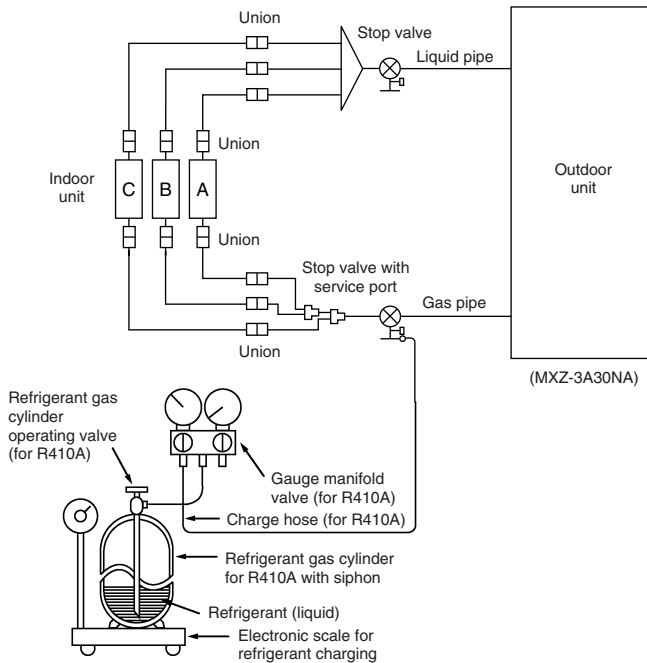

## 5-9 TEST RUN

- Be sure to perform the test run for each unit. Make sure each indoor unit operates properly following the installation manual attached to the unit.
- If you perform the test run for all indoor units at once, you cannot detect any erroneous connection, if any, of the refrigerant pipes and the indoor/outdoor unit connecting wires.

### **About the restart protective mechanism**

Once the compressor stops, the restart preventive device operates so the compressor will not operate for 3 minutes to protect the air conditioner.

## 5-10 EXPLANATION TO THE CUSTOMER

- Recommend the customer to read the OPERATING INSTRUCTIONS carefully.
- Using the OPERATING INSTRUCTIONS for each unit, explain the following to the customer, how to control temperature, how to remove the air filters, how to remove or put the remote controller in the remote controller holder, how to clean, precautions for operation, etc.

If the customer (user) is absent, explain to the purchaser (owner, building's controller, etc) about those points.